

Cable ladder systems

Splice plates

Finish: hot dip galvanised as standard. For stainless steel grade 316 add **SS** e.g. L/SSP100SSPR

Ladder depth mm	Sold in pairs (includes 16 nuts, bolts and washers)
50	L/SSP50PR
100	L/SSP100PR
125	L/SSP125PR
150	L/SSP150PR

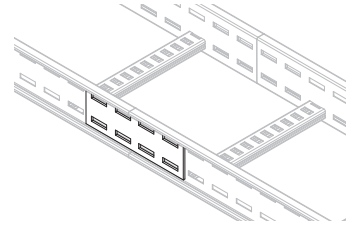

Vertical splice plates

Finish: hot dip galvanised as standard. For stainless steel grade 316 add **SS** e.g. L/VSP100SSPR

Ladder depth mm	Sold in pairs (includes 16 nuts, bolts and washers)
50	L/VSP50PR
100	L/VSP100PR
125	L/VSP125PR
150	L/VSP150PR

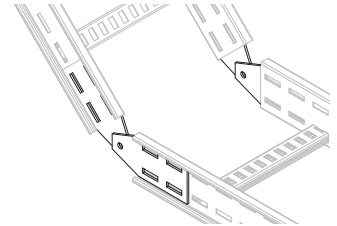

Horizontal splice plates

Finish: hot dip galvanised as standard. For stainless steel grade 316 add **SS** e.g. L/HSP100SSPR

Ladder depth mm	Sold in pairs (includes 16 nuts, bolts and washers)
50	L/HSP50PR
100	L/HSP100PR
125	L/HSP125PR
150	L/HSP150PR

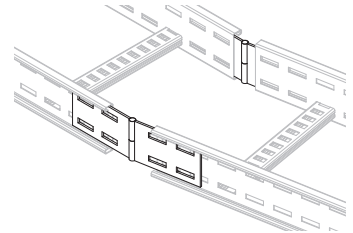

Reducer plate

Finish: hot dip galvanised as standard. For stainless steel grade 316 add **SS** e.g. L/RSP100SS

Ladder depth mm	Sold as single item (includes 8 nuts, bolts and washers)
50	L/RSP50
100	L/RSP100
125	L/RSP125
150	L/RSP150

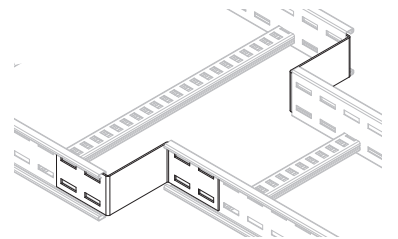

Hold down bracket

Finish: hot dip galvanised as standard. For stainless steel grade 316 add **SS** e.g. L/HDB100SS

Ladder depth mm	Sold as single item (fasteners excluded)
50	L/HDB50
100	L/HDB100
125	L/HDB125
150	L/HDB150

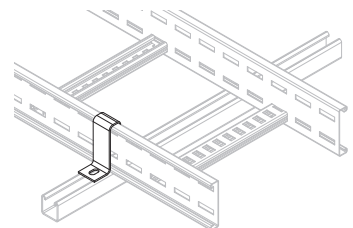

Suspension clip

Finish: hot dip galvanised as standard. For stainless steel grade 316 add **SS** e.g. L/SC100**SS**

Ladder depth depth mm	Sold as single item (Fasteners excluded)
50	L/SC50
100	L/SC100
125	L/SC125
150	L/SC150

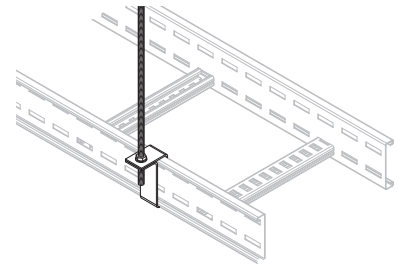

Hold down clip

Finish: hot dip galvanised as standard. For stainless steel grade 316 add **SS** e.g. L/HDC/**ASS**

Sold as single item (Fasteners excluded)
L/HDC/A

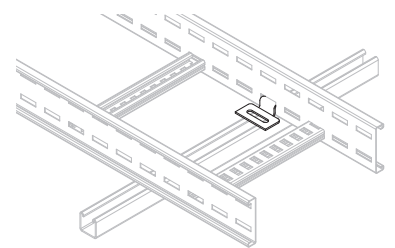

Bolted hold down clip

Finish: hot dip galvanised as standard. For stainless steel grade 316 add **SS** e.g. L/HDC/**BSS**

Sold as single item (Fasteners excluded)
L/HDC/B

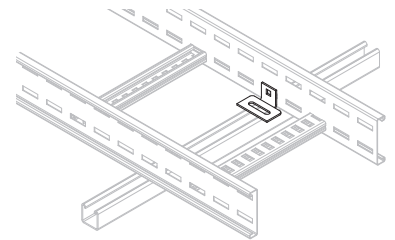

Side rail clamp

Finish: hot dip galvanised as standard. For stainless steel grade 316 add **SS** e.g. L/SRC/**SS**

Sold as single item (Fasteners excluded)
L/SRC

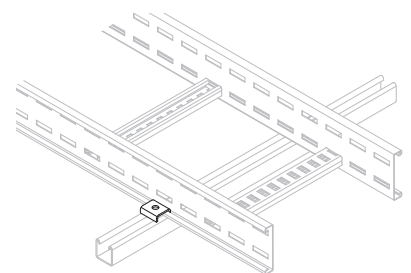

Expansion couplers

Finish: hot dip galvanised as standard. For stainless steel grade 316 add **SS** e.g. L/EC/100**SSPR**

Ladder depth mm	Sold in pairs (includes 16 nuts, bolts and washers)
50	L/EC/50PR
100	L/EC/100PR
125	L/EC/125PR
150	L/EC/150PR

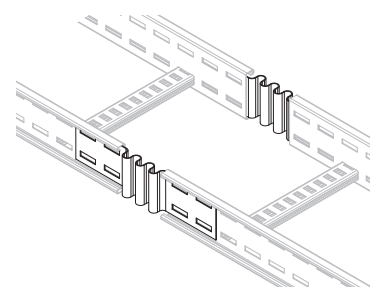

Cable ladder systems

Bendable splice plates

Finish: hot dip galvanised as standard. For stainless steel grade 316 add **SS** e.g. L/BSP100/SSPR

Ladder depth mm	Sold in pairs (includes 16 nuts, bolts and washers)
50	L/BSP050/PR
100	L/BSP100/PR
125	L/BSP125/PR
150	L/BSP150/PR

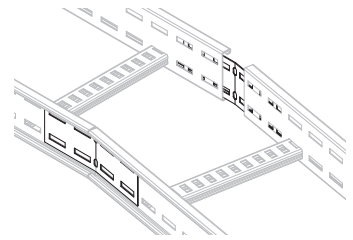

End connectors

Finish: hot dip galvanised as standard. For stainless steel grade 316 add **SS** e.g. L/ECO100SSPR

Ladder depth mm	Sold in pairs (fasteners excluded)
50	L/ECO50PR
100	L/ECO100PR
125	L/ECO125PR
150	L/ECO150PR

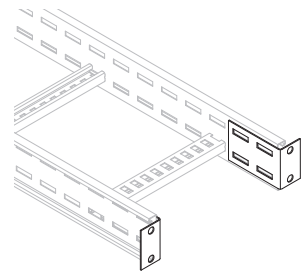

Stop ends

Finish: hot dip galvanised as standard. For stainless steel grade 316 add **SS** e.g. L/SE100/0300SS

Sold as single item (fasteners excluded)				
Width mm	Light duty 50mm deep	Medium duty 100mm deep	Heavy duty 125mm deep	Extra heavy duty 150mm deep
150	L/SE050/0150	L/SE100/0150	L/SE125/0150	L/SE150/0150
300	L/SE050/0300	L/SE100/0300	L/SE125/0300	L/SE150/0300
450	L/SE050/0450	L/SE100/0450	L/SE125/0450	L/SE150/0450
600	N/A	L/SE100/0600	L/SE125/0600	L/SE150/0600
750	N/A	L/SE100/0750	L/SE125/0750	L/SE150/0750
900	N/A	L/SE100/0900	L/SE125/0900	L/SE150/0900

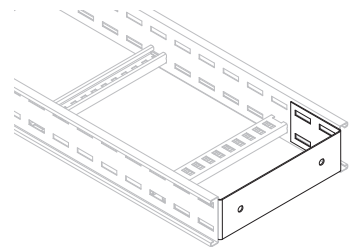

Drop out plates

Finish: hot dip galvanised as standard. For stainless steel grade 316 add **SS** e.g. L/DOP300SS

Ladder width mm	Sold as single item (fasteners excluded)
150	L/DOP150
300	L/DOP300
450	L/DOP450
600	L/DOP600
750	L/DOP750
900	L/DOP900

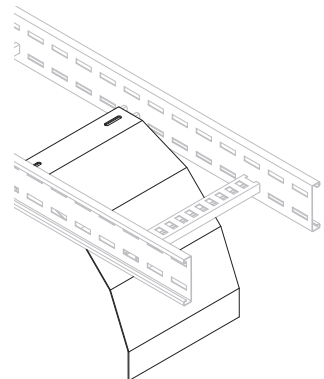

Drop out brackets

Finish: hot dip galvanised as standard. For stainless steel grade 316 add **SS** e.g. L/RTR100SS

Ladder depth mm	Sold in pairs (fasteners excluded)
50	N/A
100	L/RTR100/PR
125	L/RTR125/PR
150	L/RTR150/PR

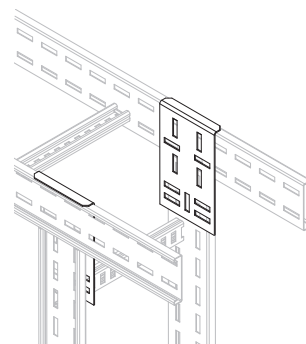

Wall brackets

Finish: hot dip galvanised as standard. For stainless steel grade 316 add **SS** e.g. L/WSB100SSPR

Ladder depth depth mm	Sold in pairs (fasteners excluded)
50	L/WSB050PR
100	L/WSB100PR
125	L/WSB125PR
150	L/WSB150PR

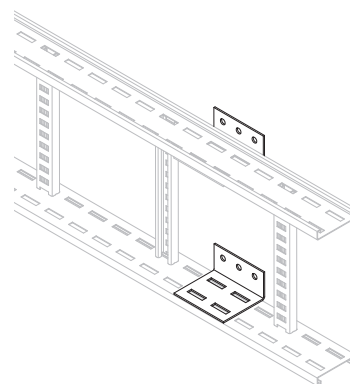

Straight divider – 3m long

Finish: hot dip galvanised as standard. For stainless steel grade 316 add **SS** e.g. LSD100/3SS

Ladder depth mm	Sold as single item (fasteners excluded)
50	LSD050/3
100	LSD100/3
125	LSD125/3
150	LSD150/3

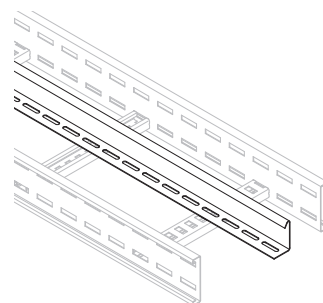

Bendable divider – 1m long

Finish: Hot Dip Galvanised as standard. For stainless steel grade 316 add **SS** e.g. LBD100/SS

Ladder depth depth mm	Sold as single item (fasteners excluded)
50	LBD050
100	LBD100
125	LBD125
150	LBD150

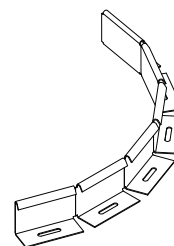

Earth straps

Finish: copper braid electroplated – 16mm²

250mm long (fasteners excluded)
L/ES250

